

MeshGuard Gamma



User's Guide



Rev. B
August 2014
P/N D01-4023-000

© Copyright 2014 RAE Systems by Honeywell.

Contents

1	Product Kits	6
1.1	Standard Kit.....	7
1.2	Optional Accessories	7
2	General Information	7
3	Physical Description	9
3.1	LCD Display.....	10
3.2	Specifications	11
4.	Operating MeshGuard Gamma.....	13
4.1	Turning MeshGuard Gamma On	13
4.2	Turning MeshGuard Gamma Off.....	15
4.3	Low Battery Indicator & Action	15
4.4	Wireless Communication Indicator	16
5	Operation Modes	16
5.1	Detection Mode	17
5.1.1	Manually Sending Data	17
5.1.2	Selecting Dose Rate Unit for Current Reading.....	18
5.2	Programming Mode.....	19
5.2.1	Entering Programming Mode	19
5.2.2	Alarm Set.....	19
5.2.3	Radio Set	21
5.2.4	LCD Contrast.....	23
5.2.5	Bump Test.....	24
6	Diagnostic Mode	25
6.1	Entering Diagnostic Mode.....	25

MeshGuard Gamma User's Guide

6.2	Exiting Diagnostic Mode.....	26
6.3	Diagnostic Mode Readings.....	26
6.3.1	Sensor Raw Count	26
6.3.2	Battery Raw Count	26
6.3.3	Temperature Raw Count	26
6.4	Diagnostic Programming Mode.....	27
6.4.1	Alarm Alerts.....	28
6.4.2	Radio Mode	29
6.4.3	Factory Set.....	29
7	Sensor and Battery Replacement.....	30
7.1	Battery replacement.....	31
7.2	Proper Battery Disposal.....	31
7.3	Sensor Replacement	32
8	Appendix A: Installation.....	33
8.1	Magnet-Mount Installation.....	33
8.2	Fixed Installation.....	34
8.3	Magnetic Mount Alternative Installation.....	37
9	Troubleshooting.....	39

MeshGuard Gamma User's Guide

WARNINGS

Read Before Operating

This manual must be carefully read by all individuals who have or will have the responsibility of using, maintaining, or servicing this product. The product will perform as designed only if it is used, maintained, and serviced in accordance with the manufacturer's instructions.

FCC Part 15 statement and CE

This device complies with Part 15 of the FCC rules. Operation is subject to the following two conditions: (1) This device may not cause harmful interference, and (2) this device must accept any interference received, including interference that may cause undesired operation.

Warning

Use only the Lithium battery or external rechargeable battery provided by RAE Systems. This instrument has not been tested in an explosive gas/air atmosphere. Replace batteries only in non-hazardous locations.

STATIC HAZARD: Clean only with a damp cloth.

For safety reasons this equipment must be operated and serviced by qualified personnel only. Read and understand instruction manual completely before operating or servicing.



MeshGuard Gamma User's Guide

1 Product Kits

1.1 Standard Kit

- Gamma detector with antenna
- Lantern mantel source for bump test
- User's Guide adapter
- CD with resources
- Battery tools
- Calibration certificate

1.2 Optional Accessories

- Stainless mounting bracket
- Cable adapter

2 General Information

MeshGuard Gamma (FTD-4000) is a rapid detector of X gamma radiation integrated with a wireless mesh network-enabled transmission radio module. It can work as a fixed device or as a portable device. The detector has the option of relaying the wireless signal to other MeshGuard Gammas detectors as needed, to bypass obstacles. The MeshGuard Gamma's built-in radio operates on a frequency of 2.4GHz and complies with IEEE 802.15.4 standard. The FTD-4000 works with the FMC-2000 wireless controller on a flexible, robust wireless network to provide reliable, low-cost operation. It also works in a ProRAE Guardian network with a PC, and it supports point-to-point and point-to-multi-point networks.

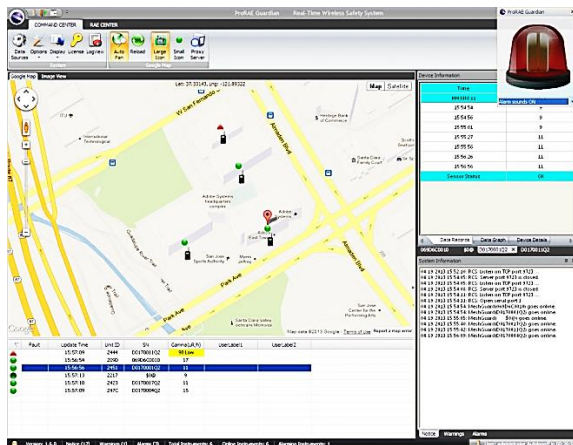

MeshGuard Gamma User's Guide

Key Features

- High sensitivity for environmental X-ray and gamma radiation monitoring
- with a wireless system of gamma detection with FMC2000 Controller and ProRAE Guardian Software via RAEMesh Reader
- Support internal D size lithium battery
- Radiological designed to comply with ANSI N42.42-2012
- Up to 1,500 hours operation
- IEEE 802.15.4 Mesh network functionality with 64-bit encryption
- Robust wireless mesh network with auto network forming and configuration
- Operating distance: up to 300 m (1,000'), line of sight
- Minimal cost for installation or relocation
- Large area coverage with multi-hop mesh network
- Field-replaceable battery and sensor
- Loud audio alarm, 90 dB at 30cm (12")
- Bright red flashing alarm
- Highly resistant to RFI interference
- Large, easy-to-read continuous display of dose rate or
- User-adjustable high and low alarms

3 Physical Description

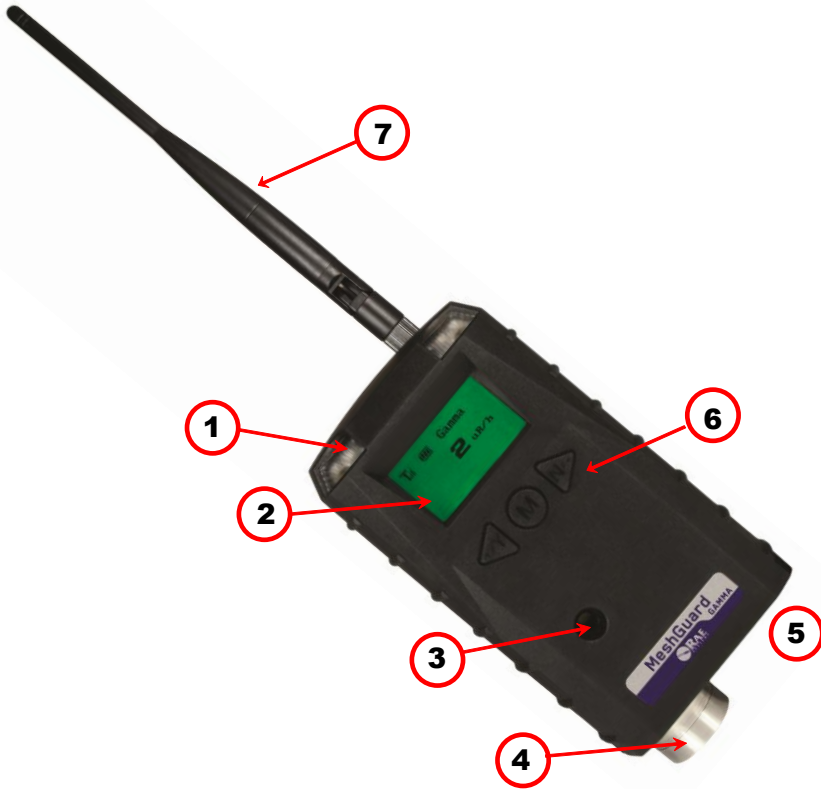

1	LED alarm
2	LCD
3	Buzzer alarm
4	Sensor cover
5	Battery cover (on bottom)
6	[Y/+], [MODE], and [N/-] keys
7	Antenna
Not visible	Optional magnetic mount on rear

MeshGuard Gamma User's Guide

3.1 LCD Display

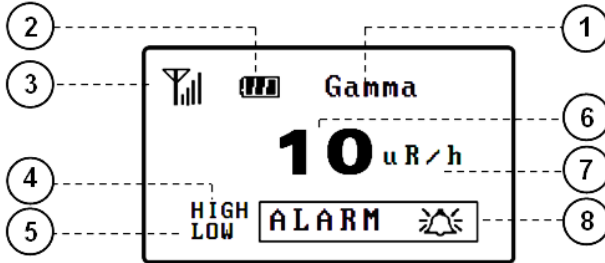

1	Operation mode indicator (shown as Gamma in Detection Mode, PROGRAMMING in Programming Mode, Diagnostic Programming Mode, and DIAGNOSTIC in Diagnostic Mode)
2	Battery Status Indicator
3	Wireless Communication
4, 8	Dose rate alarm - high
5, 8	Dose rate alarm - low
6	Reading value
7	Dose rate unit ($\mu\text{R/h}$, mR/h , $\mu\text{Gy/h}$, $\mu\text{Sv/h}$)

MeshGuard Gamma User's Guide

3.2 Specifications

Gamma Sensor	1cc CsI(Tl)/Photodiode
Dose Rate Range	1μR/h to 20mR/h/1 μR/h to 20 mR/h (0.01 μSv/h to 200 μSv/h, or 0.01 μGy/h to 200 μGy/h)
Dose Rate Accuracy	±20% (from 100 μR/h to 20mR/20 mR/h) ±30% or 5 μR/h (from 2 μR/h to 100 μR/h)
Energy Response	60keV to 3.0MeV (X-ray, gamma)
Angular response	0° to 360°, ≤ ±10% (¹³⁷ Cs) horizontal rotation with respect to center line of the gamma sensor
Dose Rate Response	T90 < 5 sec (dose rate > 1 mR/h)
Display	2" graphic LCD
Audible alarm	90dB at 30cm
Visual alarm	2 LEDs
Alarm Response	2 seconds without communication delay (alarm threshold >100μR > 100 μR/h)
Calibration	Annual calibration check is recommended.
Power Supply	1 D-size lithium battery (> 1,500 hours)
User Interface	3 keys (Y/+, MODE, N/-)
RF Certifications	FCC Part 15 CE EN 300328 SRRC
RF	IEEE 802.15.4/Zigbee with mesh stack
Operating Range	Up to 300 meters, line of sight
Transmission Power	Up to 18dBm (63mW/18 dBm (63 mW EIRP)
Receiver Sensitivity	Minimum -95dBm at 2.4GHz

MeshGuard Gamma User's Guide

Operation Time	Internal Battery: For STD* Mode: up to 60 days For RTR** Mode: up to 7 days *STD is standard-function device **RTR is router-function device
Temperature	Operating: -20° C to +50° C (-4° F to 122° F) Storage: -30° C to +70° C (-22° F to 158° F)
Humidity	Up to 95% relative humidity, non-condensing
Dimensions	17.5cm x 9.5cm x 5.5cm (6.9" L x 3.7" W x 2.1" H) excluding an antenna
Weight	600 g (1.3 lbs)
Ingress Protection	IP-54
Mounting	Optional stainless-steel bracket mount or magnetic

Brazil Radio Specifications

Radio model: RM2400A

Frequency range: 2.400-2.4835GHz

Modulation: 802.15.4 DSSS BPSK

RF power(Tx): 20dBm

Data rate: 250kbps

MeshGuard Gamma User's Guide

4. Operating MeshGuard Gamma

Make sure the battery is installed before operating the MeshGuard Gamma. Refer to page 27 for information on battery installation and replacement.

4.1 Turning MeshGuard Gamma On

Hold down the [MODE] key and release it when the MeshGuard Gamma detector beeps and/or the LCD lights flash. The monitor is now powered on, as indicated by the display:

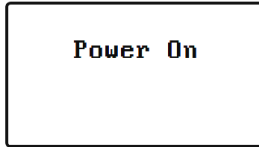

Power On

The MeshGuard Gamma performs a self-test by sequentially displaying information of the unit (including firmware version, build date and time, serial number, the date when the latest calibration was performed and the date when the next calibration is recommended), followed by warm-up lasting for 30 seconds.

Firmware V1.00	Build Date March 26 2013
Build Time 16:20:52	Serial Number d0170017q2
Last Calibration Apr 2 2013	Calibration Due Jun 26 2014
Warm Up 27	

MeshGuard Gamma User's Guide

Then, if the MeshGuard Gamma is set to operate in the STD or RTR mode (that is, with the radio on), it attempts to initialize the wireless network and sequentially displays this information:

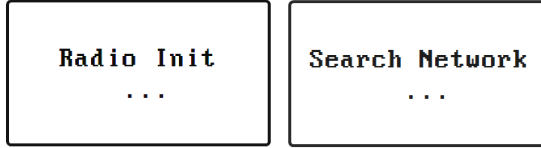

Next, the instrument starts to operate in the Detection Mode (see page 15) and the current dose rate reading is displayed, regardless of whether a network can be located.

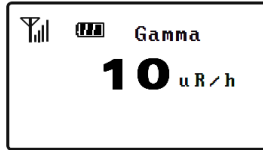

Note: If the MeshGuard Gamma has succeeded in being connected to a wireless network, an antenna icon with vertical lines on its right side (shown as the above figure) appears. Otherwise, an antenna icon with a cross symbol on its right side ($\nabla \times$) appears.

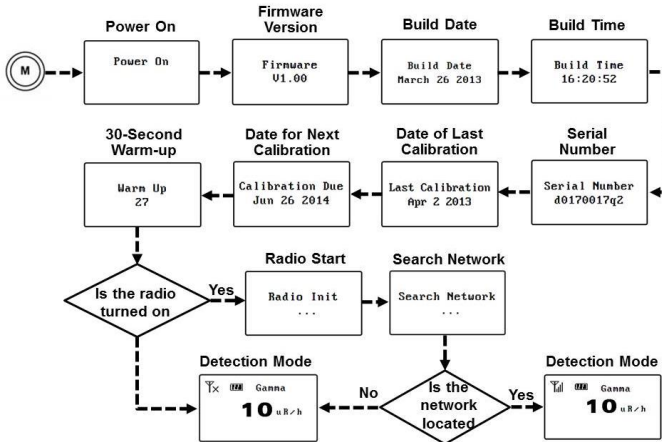

MeshGuard Gamma User's Guide

4.2 Turning MeshGuard Gamma Off

Hold down the [MODE] key until the 5-second countdown is over and the display becomes blank. Release the [MODE] key.

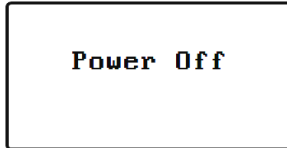

The MeshGuard Gamma is now off.

4.3 Low Battery Indicator & Action

The MeshGuard Gamma's battery is designed for up to more than 60 days' life in STD mode (in RTR mode, including the MeshGuard Router's normal operation, battery life is up to 7 days). When the battery gets low (that is, the battery icon appears empty, as shown in the following figure), the LED lights flash once per minute. It is recommended that the battery be changed immediately, to minimize disruption.

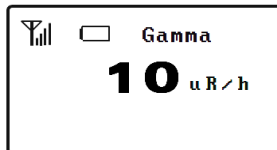

When the battery is completely depleted, the LCD sequentially displays “Low Power” and “Power Off,” and the MeshGuard Gamma shuts down automatically soon after that.

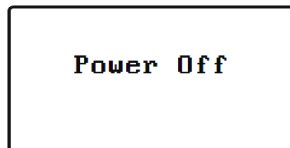
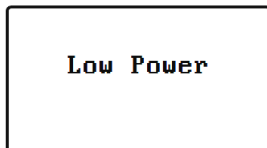

MeshGuard Gamma User's Guide

4.4 Wireless Communication Indicator

When wireless communication is turned on, the LCD displays the wireless link status in the upper left corner. If it finds and joins a wireless network, the LCD displays an antenna icon with vertical lines on its right side:



If no link or a weak link is established, the LCD displays an antenna icon with a cross symbol on its right side:



5 Operation Modes

The MeshGuard Gamma can operate as a standard (STD) or a router-mode (RTR) device. In STD mode, the MeshGuard Gamma transmits data to the host at a set interval (the default is 30 seconds) or anytime an alarm occurs. In RTR mode, the MeshGuard Gamma receives data in real time, and it can also work as a router as needed to relay data from STD devices back to the host.

Note: Operating the MeshGuard Gamma in RTR mode reduces battery life. The interval can be changed in Programming Mode. See page 19 for details.

In addition, there is a Detection Mode for standard operation, Programming Mode for making changes to values (such as the High Dose Rate Alarm, etc.), Diagnostic Mode (for servicing and checking the sensor, etc.), and Diagnostic Programming Mode for selecting between STD and RTR modes, etc.

MeshGuard Gamma User's Guide

5.1 Detection Mode

After the MeshGuard Gamma is turned on, it enters the Detection Mode and displays the current reading:

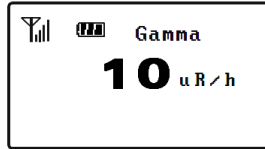

Pressing [MODE] steps through the Detection Mode screens:

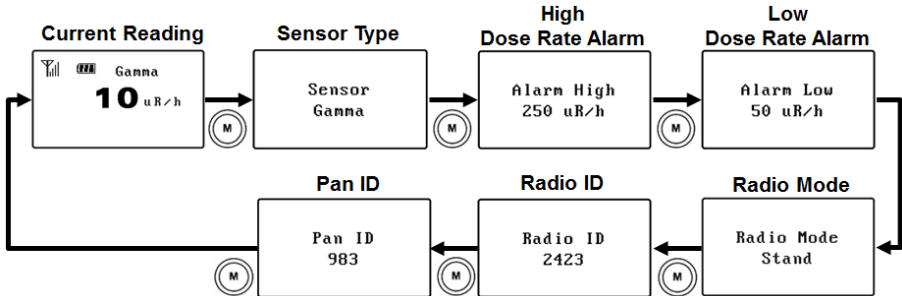

5.1.1 Manually Sending Data

While the MeshGuard Gamma typically sends data to the network on a fixed interval, you can send the data anytime.

Press the [Y/+] key. The screen shows “Send Data ...”, and it attempts to send the current sensor data. If it succeeds, the screen displays “Sending Data Successful” and otherwise displays “Sending Data Failed”, and returns to the detector reading.

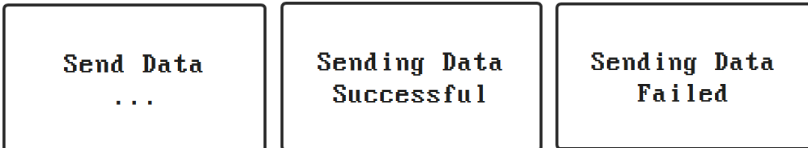

MeshGuard Gamma User's Guide

5.1.2 Selecting Dose Rate Unit for Current Reading

The MeshGuard Gamma can display dose rate in three unit systems, Roentgen (R), Sievert (Sv) and Gray (Gy). Press the [N/-] key to select a unit system in which the current reading is preferred to be displayed. Once a unit system is selected, the current reading is always displayed until another unit system is selected.



MeshGuard Gamma User's Guide

5.2 Programming Mode

Programming Mode allows you to perform any of the following actions (listed in order of appearance):

- Changing preset dose rate alarm thresholds
- Setting parameters for wireless connection
- Adjusting LCD contrast
- Performing a bump test

5.2.1 Entering Programming Mode

To enter the Programming Mode, press [MODE] and [N/-] for 3 seconds. This mode provides a menu that includes the following options:

- Alarm Set
- Radio Set
- LCD Contrast
- Bump Test
- Quit

The currently selected option is highlighted by the black bar behind the text. Press [Y/+] to enter a submenu subject to the highlighted option. Press [MODE] to advance to the next option.

When the option “Quit” is highlighted, press [Y/+] to exit and return to the Detection Mode.

5.2.2 Alarm Set

This submenu allows you to change the high and low dose rate alarm thresholds. It includes following options:

- Alarm High
- Alarm Low
- Quit

The currently selected option is highlighted by the black bar behind the text. Press [MODE] to advance to the next option. Press [Y/+] to enter and change the setting. When “Quit” is highlighted, pressing [Y/+] navigates you to exit the submenu and return to the main menu.

MeshGuard Gamma User's Guide

To change the high dose rate alarm threshold, press [Y/+] when the option “Alarm High” is highlighted. The following screen is displayed:

```
PROGRAMMING
Alarm High
0250 uR/h
Save Quit
```

The LCD has seven active fields, four digits of the current setting value, the dose rate unit section, the “Save” section, and the “Quit” section. Press [MODE] to highlight the next active field, or to highlight the first active field if the last active field is currently highlighted. When “Quit” is highlighted, press [Y/+] to exit to the upper menu at any time.

To change the current setting value:

1. Press [Y/+] to increase the number of the highlighted digit and [N/-] to decrease it.
2. Press [MODE] to advance to the next digit.
3. After moving to the last digit and making changes, press [MODE] to highlight the dose rate unit section.

```
PROGRAMMING
Alarm High
0250 uR/h
Save Quit
```

4. Press [Y/+] to switch the current unit to the next one of the options $\mu\text{R/h}$, $\mu\text{Sv/h}$, $\mu\text{Gy/h}$ and mR/h in the order. Select the desired unit option by making it displayed.

Press [MODE] to highlight the “Save” section and then press [Y/+] to save the changes. It exits the current screen and returns to the upper menu.

MeshGuard Gamma User's Guide

The low dose rate alarm threshold can be changed in a similar way, except that pressing [Y/+] when the option “Alarm Low” is highlighted makes the following screen display:

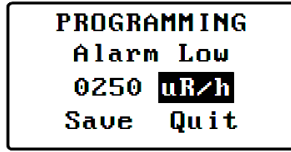

Note: The valid range for both the high and low alarm thresholds are 1 to 9999, if you set a number outside this range (for example, 0), it cannot be successfully saved and an error warning message appears at the bottom of the screen.

5.2.3 Radio Set

This submenu allows you to set the Pan ID for a wireless network, join the network, and change the interval for regular communications between the MeshGuard Gamma and the network. The submenu includes the following options:

- Pan ID (valid range: 1 to 999)
- Interval (valid range: 10 to 255)
- Join Network
- Quit

The currently selected option is highlighted by the black bar behind the text. Press [MODE] to advance to the next option. Press [Y/+] to enter and change the setting. When “Quit” is highlighted, pressing [Y/+] navigates you to exit this submenu and return to the main menu.

To set the Pan ID, press [Y/+] when the option “Pan ID” is highlighted. The following screen is displayed:

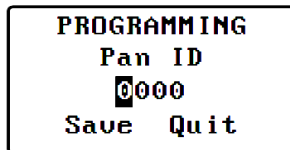

The display has six active fields, four digits of the current setting value, the “Save” section, and the “Quit” section. Press [MODE] to highlight the next

MeshGuard Gamma User's Guide

active field, or to highlight the first active field if the last active field is currently highlighted.. When “Quit” is highlighted, press [Y/+] to exit to the upper menu at any time.

To change the current setting value:

1. Press [Y/+] to increase the number of the highlighted digit and [N/-] to decrease it.
2. Press [MODE] to advance to the next digit.
3. After moving to the last digit and making changes, press [MODE] to highlight the “Save” section.

Press [Y/+] to save the changes. It exits to the upper menu.

The data communication interval can be changed in a similar way, except this screen is displayed if you press [Y/+] when the option “Interval” is highlighted:



Note: The valid ranges for the Pan ID and interval are 1 to 999 and 10 to 255, respectively. If a number is set outside these ranges (for example, 0), it cannot be successfully saved and an error message appears at the bottom of the screen.

To join the wireless network associated with the preset Pan ID, press [Y/-] when the option “Join Network” is highlighted. A 30-second countdown proceeds while it searches.

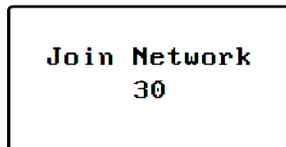

MeshGuard Gamma User's Guide

After the countdown has finished, if it succeeds, “Yes” is displayed. If it fails, “No” is displayed. Refer to Section 9, Troubleshooting, if the detector fails to connect to a network.

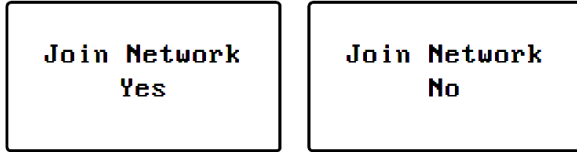

5.2.4 LCD Contrast

This submenu allows you to change LCD contrast. Press [Y/+] when the option “LCD Contrast” is highlighted. The following screen is displayed:

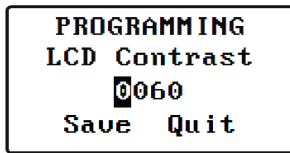

The LCD has six active fields, four digits of the current setting value, the “Save” section and the “Quit” section. Press [MODE] to highlight the next active field, or to highlight the first active field if the last active field is currently highlighted. When “Quit” is highlighted, press [Y/+] to exit to the upper menu at any time.

To change the current setting value:

1. Press [Y/+] to increase the number of the highlighted digit and [N/-] to decrease it.
2. Press [MODE] to advance to the next digit.
3. After moving to the last digit and making changes, press [MODE] to highlight the “Save” section.
4. Press [Y/+] to save the changes. It exits and returns to the upper menu.

Note: The valid range for the LCD contrast is 1 to 100. If a number is set outside this range, it cannot be successfully saved and an error message appears at the bottom of the screen.

MeshGuard Gamma User's Guide

5.2.5 Bump Test

This submenu allows you to perform a bump test to verify whether the MeshGuard Gamma detector normally alarms when ambient dose rate level is higher than the preset low threshold. Press [Y/+] when the option “Bump Test” is highlighted, and the following screen is displayed:

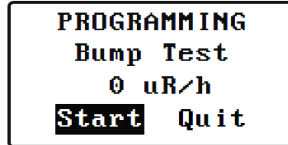

The display has two active fields, “Start” and “Quit.” Press [MODE] to select between them. When “Quit” is highlighted, press [Y/+] to exit to the upper menu at any time.

To start the bump test:

1. Press [MODE] to highlight “Start.”
2. Bring a gamma check source (such as a lantern mantel; the maximum dose rate it can provide is about $100\mu\text{R/h}$) into close proximity with the MeshGuard Gamma sensor located on the bottom of the detector (Reference the diagram on page 9).
3. Press [Y/+] to start a 30-second measurement of ambient the dose rate level. During the measurement, the countdown and dose rate are displayed:

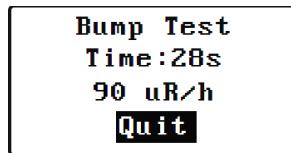

Note: During measurement, “Quit” is always highlighted. Press [Y/+] to stop the bump test at any time.

MeshGuard Gamma User's Guide

4. After the measurement, a test report screen shows the maximum measurement value and the test result:

Bump Test
95 uR/h
Pass

Bump Test
30 uR/h
Fail

Note: In normal operation, if the maximum value exceeds the preset low threshold value, the test result is “Pass.” Otherwise, it is “Fail.”

6 Diagnostic Mode

Diagnostic Mode provides raw data from the gamma sensor and other information useful to technicians when troubleshooting or repairing the instrument.

6.1 Entering Diagnostic Mode

Note: To enter Diagnostic Mode, you must begin with the MeshGuard Gamma turned off.

Press and hold [Y/+] and [MODE] until the MeshGuard Gamma starts.

The instrument displays “Diagnostic Mode” and goes through a 30-second warm-up. It then switches to showing raw data for the battery.

The following chart shows how to navigate Diagnostic Mode (pressing [N/-] repeatedly steps through the screens):

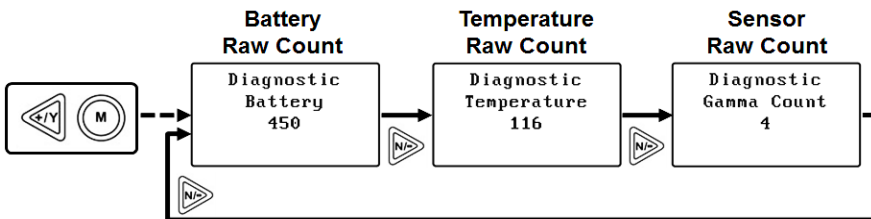

MeshGuard Gamma User's Guide

6.2 Exiting Diagnostic Mode

Note: You can exit Diagnostic Mode and enter Programming Mode and configure settings of the MeshGuard Gamma as usual by pressing both [MODE] and [N/-] for three seconds.

Note: You can exit Diagnostic Mode and enter Detection Mode by pressing [MODE] and [Y/+] together for three seconds, or by turning it off and on again.

6.3 Diagnostic Mode Readings

In Diagnostic mode, you can step through readings by pressing [N/-].

6.3.1 Sensor Raw Count

Sensor Raw Count is indicated by “Gamma Count” followed by a number.

- Press [N/-] to advance to the next reading.
- Press [MODE] and [Y/+] together for three seconds to exit Diagnostic Mode and enter Detection Mode.

6.3.2 Battery Raw Count

Battery Raw Count is indicated by “Battery” followed by a number.

- Press [N/-] to advance to the next reading.
- Press [MODE] and [Y/+] together for three seconds to exit Diagnostic Mode and enter Detection Mode.

6.3.3 Temperature Raw Count

Temperature Raw Count is indicated by “Temperature” followed by a number.

- Press [N/-] to advance to the next reading.
- Press [MODE] and [Y/+] together for three seconds to exit Diagnostic Mode and enter Detection Mode.

MeshGuard Gamma User's Guide

6.4 Diagnostic Programming Mode

You can enter a special programming mode from Diagnostic Mode in order to perform advanced programming functions. These include:

- Enable/disable audible and visible alarms
- Enable Radio
- Enable STD or RTR
- Return MeshGuard Gamma to original factory settings

Important! After you make changes in Diagnostic Mode, it is recommended that you turn off the MeshGuard Gamma and turn it on again before using it.

Enter this programming mode by first entering Diagnostic Mode. This requires starting the MeshGuard Gamma while holding [Y/+] and [MODE]. When you see the Battery Raw Count screen, hold [MODE] and [N/-] until you see the “PROGRAMMING” menu in the display, indicating that you are in Diagnostic Programming Mode.

The menu includes the following options:

- Alarm Alerts
- Radio Mode
- Factory Set
- Quit

The currently selected option is highlighted by the black bar behind the text. Press [Y/+] to enter a submenu subject to the highlighted option. Press [MODE] to advance to the next option.

MeshGuard Gamma User's Guide

When the option “Quit” is highlighted, press [Y/+] to exit and return to the Diagnostic Mode.

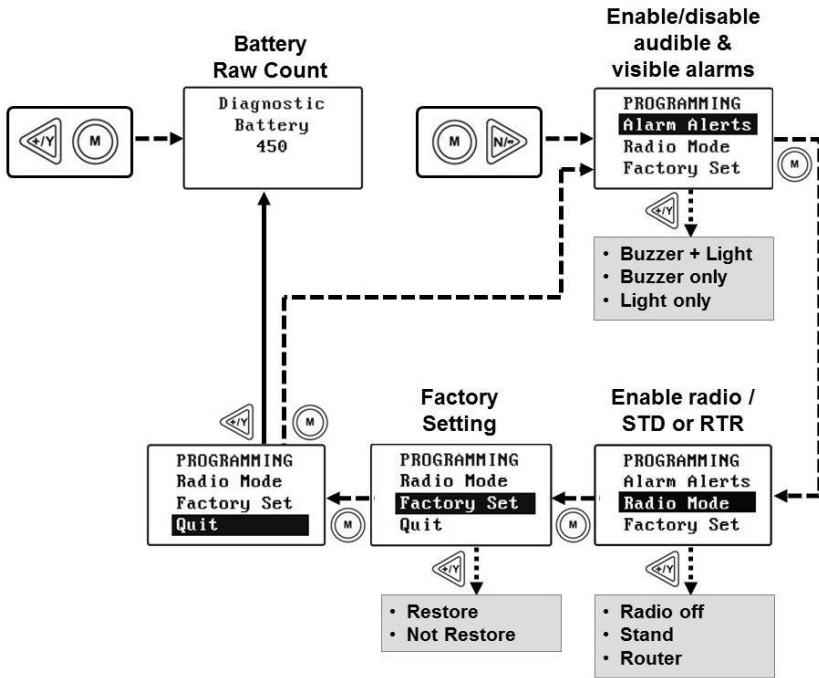

6.4.1 Alarm Alerts

This submenu allows you to enable/disable audible and visible alarms. It includes following options:

- Buzzer plus light
- Buzzer only
- Light only

The currently selected option is highlighted by the black bar behind the text. Press [MODE] to advance to the next option. Press [Y/+] to select an option and exit the submenu.

MeshGuard Gamma User's Guide

6.4.2 Radio Mode

This submenu allows you to turn off the radio or set the instrument to operate in the STD or RTR mode. It includes following options:

- Radio off
- Stand
- Router

The currently selected option is highlighted by the black bar behind the text. Press [MODE] to advance to the next option. Press [Y/+] when one of the options is highlighted to enable the corresponding setting as shown in the following table and exit the submenu.

Radio off	Turn off the radio
Stand	Set the instrument to operate in STD mode
Router	Set the instrument to operate in RTR mode
Quit	Maintain the current operating mode

6.4.3 Factory Set

This submenu allows you to return the MeshGuard Gamma to its original factory settings. It includes following options:

- Restore
- Not restore

The currently selected option is highlighted by the black bar behind the text. Press [MODE] to advance to the next option. Press [Y/+] to select an option and exit the submenu.

7 Sensor and Battery Replacement

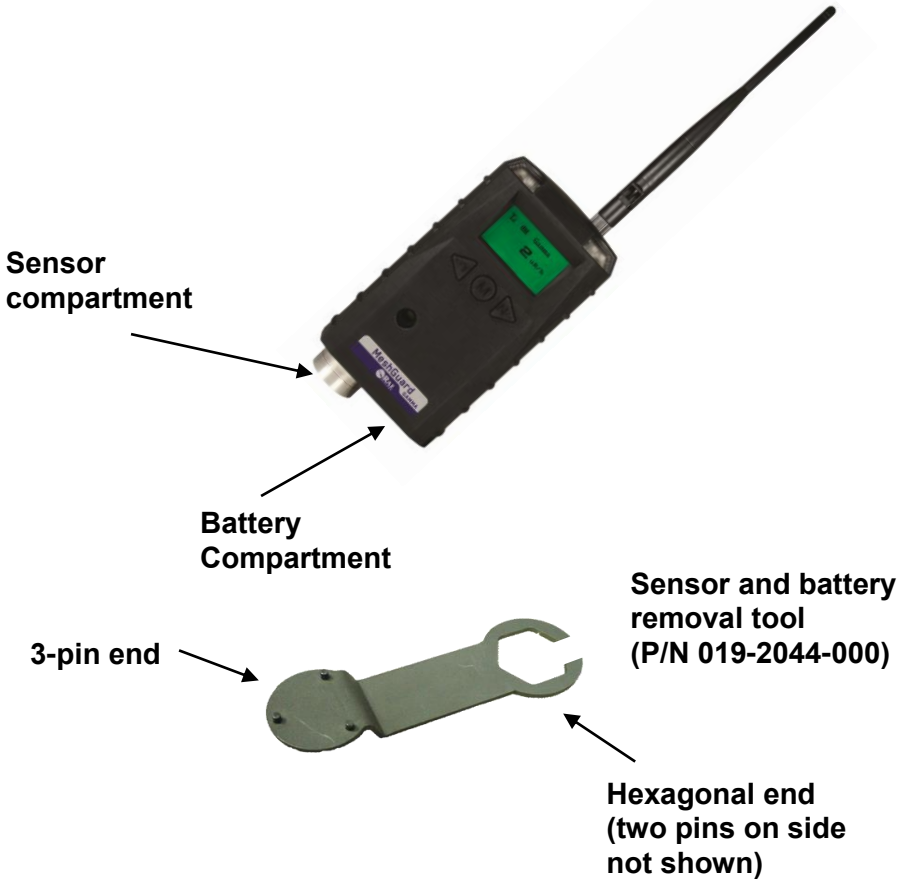

MeshGuard Gamma User's Guide

7.1 Battery replacement

1. Use the 3-pin end of the tool to unscrew and open the battery cover by turning it counterclockwise.
2. Remove the battery.
3. Insert the new battery with its positive (“+”) pole towards inside of the unit.
4. Replace the battery cover by turning it clockwise with the 3-pin end of the tool.

Note: Only change internal battery in a safe location and use the battery RAE Systems provided (P/N: 500-0111-000), model ER34615 or XL-205F.

After changing the battery, wait at least 60 seconds before turning the MeshGuard Gamma on.



7.2 Proper Battery Disposal

This product may contain one or more sealed lead-acid, nickel- cadmium (NiCd), nickel-metal hydride (NiMH), lithium (Li), or lithium-ion batteries. Specific battery information is given in this user guide. Batteries must be recycled or disposed of properly.



This symbol (crossed-out wheeled bin) indicates separate collection of waste electrical and electronic equipment in the EU countries. Please do not throw the equipment into the domestic refuse. Please use the return and collection systems available in your country for the disposal of this product.

MeshGuard Gamma User's Guide

7.3 Sensor Replacement

1. Unscrew and open the sensor cover at the bottom of the monitor by turning it counterclockwise.

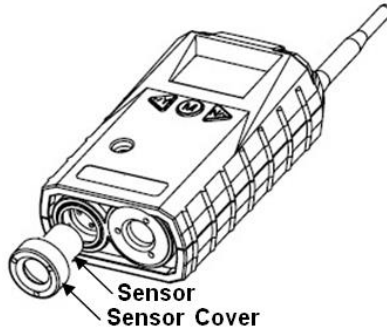

2. Pull the old sensor out.
3. Gently push a new sensor into the compartment.

Important! Ensure that the RAE Systems part number matches the sensor that was removed.

WARNING! Use only the same sensor model as the one installed when the monitor was purchased.

4. Replace the sensor cover by turning it clockwise.

8 Appendix A: Installation

Two methods for mounting the MeshGuard Gamma make it easy to install. The first method uses a magnet that screws onto the rear of the MeshGuard Gamma, making ideal for moving from one location to another. The second method uses a specially designed stainless-steel enclosure that is permanently mounted. It protects the MeshGuard Gamma from damage in industrial settings.

8.1 Magnet-Mount Installation

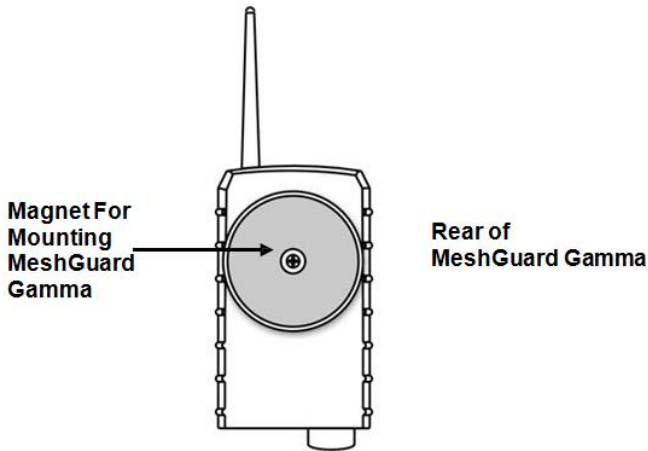

This magnet is powerful enough to support the MeshGuard Gamma when it is placed against a flat steel or iron surface.

Important! Keep the magnet away from computer hard drives. The strong magnet can corrupt or erase data on these.

MeshGuard Gamma User's Guide

8.2 Fixed Installation

Four reinforced holes in the rear of the enclosure allow for a screw to pass through to the mounting brackets.

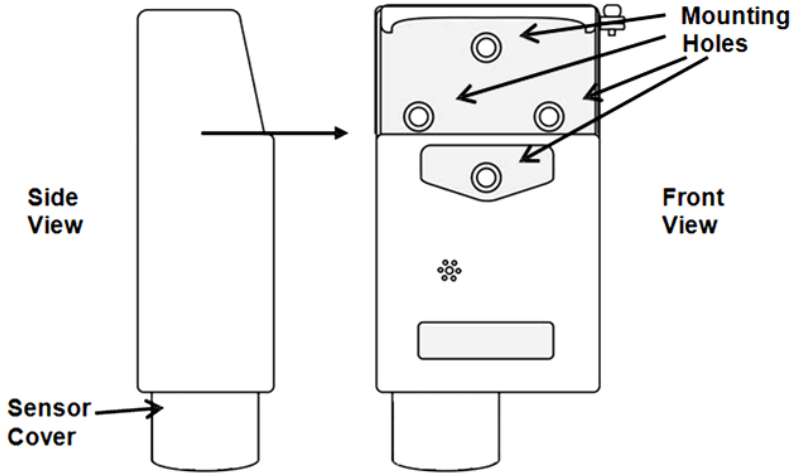

The enclosure can be mounted to a vertical or horizontal pole.

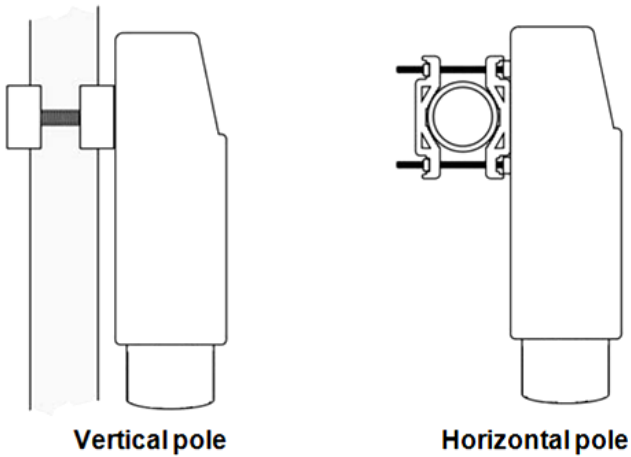

MeshGuard Gamma User's Guide

Slip the screws through the two holes that are side by side in order to mount the enclosure to a vertical pole. Otherwise slip the screws through the two vertically aligned holes to attach the enclosure to a horizontal pole.

Loosely assemble the clamp parts around the pole. Note that the screws have nuts that fit into the clamp parts. The clamp parts are designed to hold the nut so that you do not need to use a wrench. Hand-tighten the parts until snug.

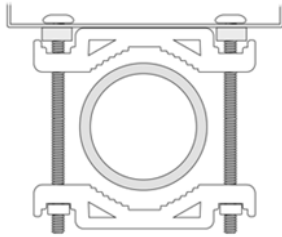

Tighten the hex screws from the front of the enclosure:



Once the clamp parts and the enclosure are securely held against the pole, stop tightening.

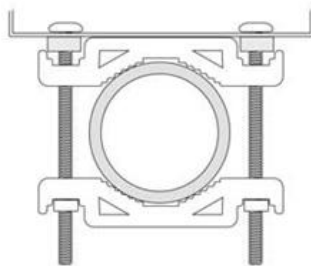

Note: The pole must be between 25mm (1") and 63mm (2.5") in diameter.

Next, place the MeshGuard Gamma into the enclosure:

1. Lift up the hinged cover of the enclosure.

MeshGuard Gamma User's Guide

2. Slide the MeshGuard Gamma into the enclosure from the top.
3. Close the cover of the enclosure.
4. Insert the hex screw into the cover's locking portion, and tighten it.
5. The MeshGuard Gamma is now ready to use.

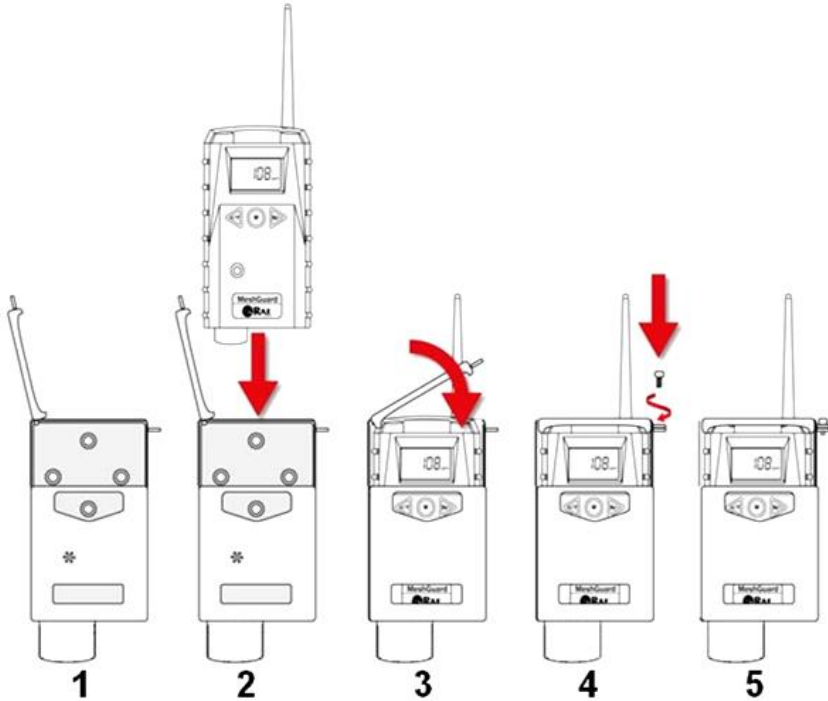

Note: The sensor cover on the bottom of the enclosure can be removed so that the sensor can be inspected without removing the MeshGuard Gamma from the enclosure. Simply pull off the cover and follow the maintenance procedures in this guide.

MeshGuard Gamma User's Guide

8.3 Magnetic Mount Alternative Installation

The magnet-mount disc can be attached to the steel enclosure instead of the clamps. This approach provides the protection of the enclosure with the ease of installation afforded by the magnetic mounting.

1. Insert screw through magnetic disc.
2. Place the magnetic disc over the bottom hole on the rear of the enclosure.
3. Tighten the screw until the disc is snug.

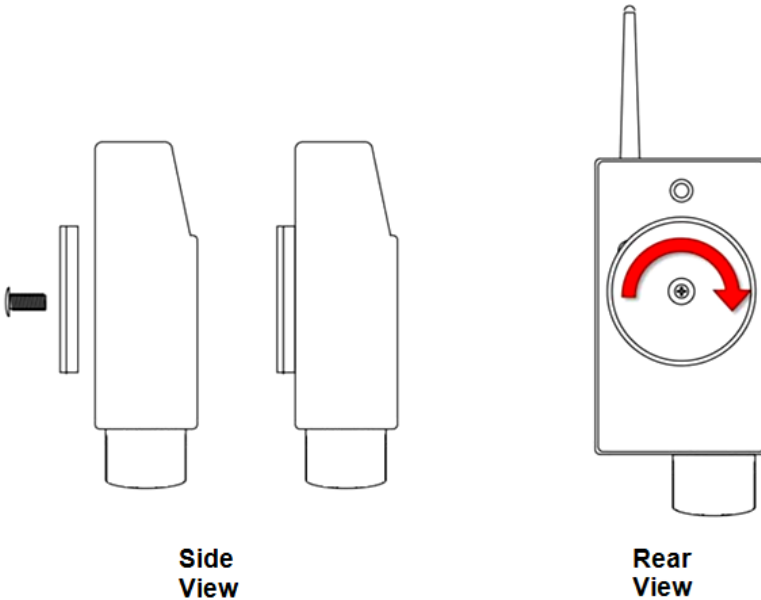

MeshGuard Gamma User's Guide

Ordering Replacement Parts: If you need replacement parts, a list is available online: <http://www.raesystems.com>

Year of Manufacture

To identify the year of manufacture, refer to the serial number of the instrument.

The second to last digit in the serial number indicates the year of manufacture. For example, “Q” indicates the manufacturing year is 2013.

First digit	Year
Q	2013
R	2014
S	2015
T	2016
U	2017
V	2018
W	2019

MeshGuard Gamma User's Guide

9 Troubleshooting

Failure Symptom	Cause	Solution
Cannot turn on	<p>Battery charge too low</p> <p>Battery has been changed</p> <p>New battery needs to be discharged before use</p>	<p>Replace battery</p> <p>Wait at least 60 seconds to turn on MeshGuard</p> <p>Check RAE Systems web site for information on batteries</p>
Abnormally high reading	<p>Incorrect radiation calibration</p> <p>Sensor malfunction</p>	<p>Recalibrate</p> <p>Replace the sensor</p>
Always displays zero	Sensor failure	Replace the sensor
Controller cannot receive the MeshGuard Gamma's signal	<p>Too much distance between the MeshGuard Gamma and the controller.</p> <p>There is an obstruction between the MeshGuard Gamma and the controller.</p> <p>Controller does not receive completed data packet</p>	<p>The distance should be 300 m, line of sight.</p> <p>Deploy RTR MeshGuard Gamma or MeshGuard Router(s). Relocate the MeshGuard Gamma or deploy RTR MeshGuard Gamma or MeshGuard Router(s).</p> <p>Press [Y/+] on the detector to force it to send data packets</p>

MeshGuard Gamma User's Guide

	<p>Battery is low</p> <p>MeshGuard Gamma and controller have different Pan ID numbers</p>	<p>Replace battery</p> <p>Set both units to have the same Pan ID number</p>
<p>Always displays  when MeshGuard Gamma is set ready for wireless communications</p>	<p>There is no reader or controller nearby.</p> <p>The controller or reader's network has changed.</p> <p>The MeshGuard Gamma is out of its RF range.</p> <p>Battery is low</p>	<p>Move the MeshGuard Gamma closer to a working controller or reader.</p> <p>Perform the network searching function in diagnostic mode.</p> <p>Move the MeshGuard Gamma close to a working controller or reader and Press [Y/+]</p> <p>Replace battery</p>
<p>Occurrence of false alarming</p>	<p>EMI interference</p> <p>Low battery</p> <p>Sensor failure</p>	<p>Check whether there is a strong EMI source nearby</p> <p>Replace the battery</p> <p>Replace the sensor</p>
<p>Others</p>		<p>Turn MeshGuard Gamma off and on again.</p> <p>Consult RAE Systems Customer Service.</p>

contém o módulo wireless: RM2400A



2783-14-6496



(01)07898911288388

Este equipamento opera em caráter secundário, isto é, não tem direito a proteção contra interferência prejudicial, mesmo de estações do mesmo tipo, e não pode causar interferência a sistemas operando em caráter primário.



**RAE Systems
by Honeywell
World Headquarters**

3775 N. First St.
San Jose, CA 95134-1708 USA
Phone: 408.952.8200
Toll-Free: 888.723.4800
Fax: 408.952.8480

E-mail (sales support): raesales@raesystems.com

E-mail (technical support): tech@raesystems.com

Web Site: www.raesystems.com

EMEA Headquarters

Life Safety Distribution AG
Javastrasse 2 • 8604 Hegnau, Switzerland
Email: haexpert@honeywell.com • Phone: +41 (0)44 943 4300
Fax: +41 (0)44 943 4398

RAE Systems (Hong Kong) Ltd.

Units 1516-18, 15/F, Delta House, 3 On Yiu Street
Shatin, N.T. Hong Kong
Web: www.raesystems.cn • Email: asiasales@raesystems.com
Phone: +852.2669.0828

Rev. B
August 2014
P/N D01-4023-000